

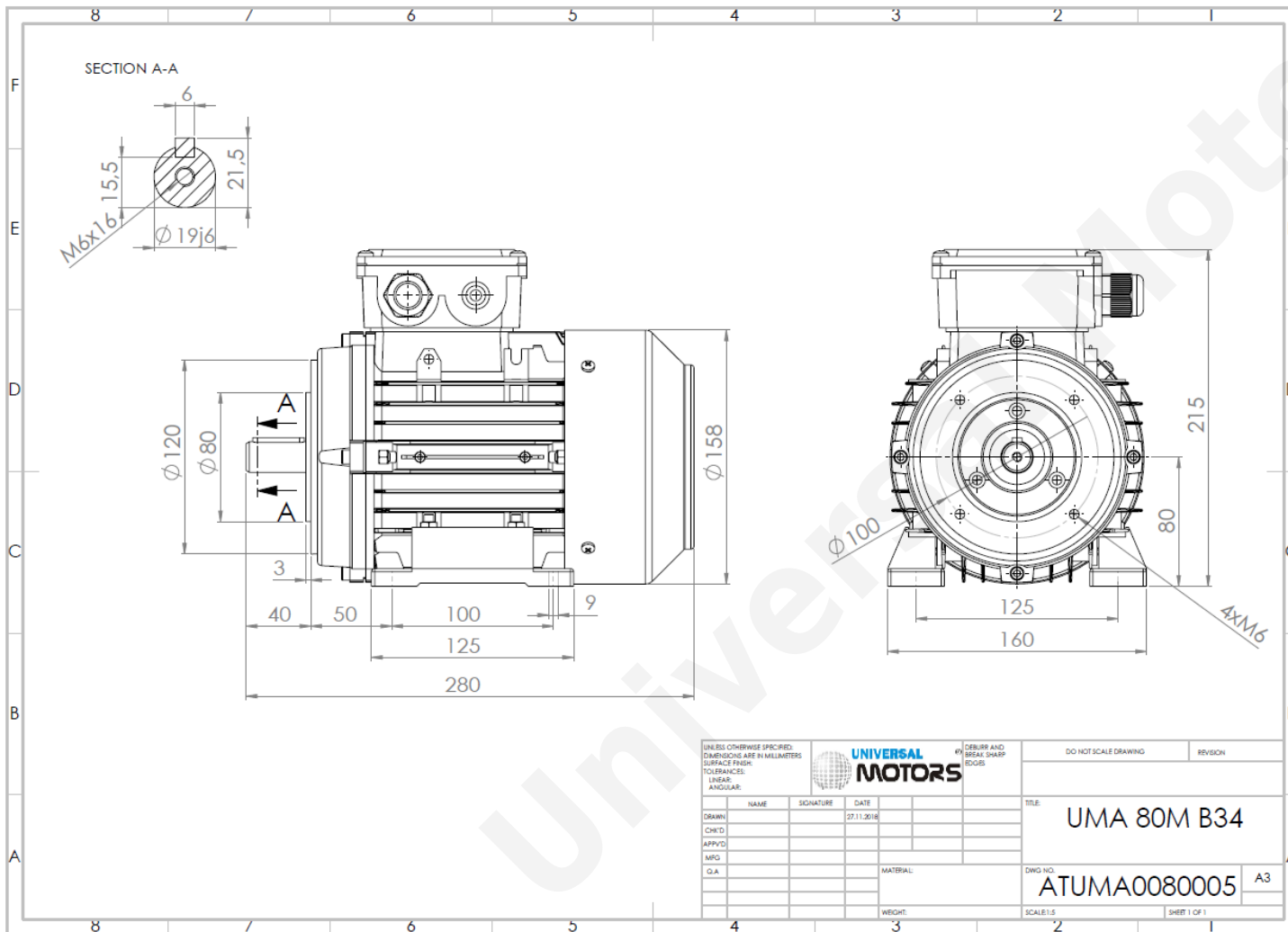

TECHNICAL DATA

Three Phase Electric Motors - Aluminum Frame
 UM3A 80M3-4 IE3
 1.1 kW / 1.5 Cv
 1430 RPM



Motor type:	UM3A 80M3-4 IE3
Output:	1.1 kW / 1.5 Cv
Speed (min ⁻¹):	1430 RPM
Frequency:	50 Hz
Voltage:	400 V
Current:	2.55 A
Power factor (Cos Ø):	0.74
Poles:	4
Insulation class:	F
Temperature rise Class:	B
Efficiency 50%:	83.7 %
Efficiency 75%:	84.9 %
Efficiency 100%:	84.1 %
Torque:	7.3 N.m
Tstarting/Tnominal:	3.0
Istarting/Inominal:	6.6
Tmaximum/Tnominal:	3.1
Noise:	61 Db(A)
Weight:	13.8 Kg
Brake AC:	AC3
Torque Brake DC:	8 N.m
Bearing DE:	6204 2Z
Bearing NDE:	6204 2Z
Torque Brake AC:	15 N.m
Brake DC:	REB-05-08

Regime - S1

Altitude - 1000m

Environment Temperature - 40°C

CONTACTS:

UNIVERSAL MOTORS Tel: +351 252 299 080
 Rua de São Brás,745 Fax: +351 252 299 089
 4480-782 VILA DO CONDE Mail: geral@universalmotors.pt

* References applied only in the UK